



power contactor, AC-3e/AC-3, 12 A, 5.5 kW / 400 V, 3-pole, 24 V DC, auxiliary contacts: 1 NO, screw terminal, size: S00

















<b>product brand name</b>	SIRIUS
<b>product designation</b>	Power contactor
<b>product type designation</b>	3RT2
<b>General technical data</b>	
<b>size of contactor</b>	S00
<b>product extension</b>	
• function module for communication	No
• auxiliary switch	Yes
<b>power loss [W] for rated value of the current</b>	
• at AC in hot operating state	1.5 W
• at AC in hot operating state per pole	0.5 W
• without load current share typical	4 W
<b>type of calculation of power loss current-dependent</b>	quadratic
<b>insulation voltage</b>	
• of main circuit with degree of pollution 3 rated value	690 V
• of auxiliary circuit with degree of pollution 3 rated value	690 V
<b>surge voltage resistance</b>	
• of main circuit rated value	6 kV
• of auxiliary circuit rated value	6 kV
maximum permissible voltage for protective separation between coil and main contacts according to EN 60947-1	400 V
<b>shock resistance at rectangular impulse</b>	
• at DC	7.3 g / 5 ms, 4.7 g / 10 ms
<b>shock resistance with sine pulse</b>	
• at DC	11,4 g / 5 ms, 7,3g / 10 ms
<b>mechanical service life (operating cycles)</b>	
• of contactor typical	30 000 000
• of the contactor with added electronically optimized auxiliary switch block typical	5 000 000
• of the contactor with added auxiliary switch block typical	10 000 000
<b>reference code according to IEC 81346-2</b>	Q
<b>Substance Prohibitance (day/month/year)</b>	10/01/2009
<b>Net Weight</b>	291 g
<b>Ambient conditions</b>	
installation altitude at height above sea level maximum	2 000 m
<b>ambient temperature</b>	
• during operation	-25 ... +60 °C
• during storage	-55 ... +80 °C
<b>relative humidity minimum</b>	10 %
<b>relative humidity at 55 °C according to IEC 60068-2-30</b>	95 %

maximum	
<b>Main circuit</b>	
number of poles for main current circuit	3
number of NO contacts for main contacts	3
number of NC contacts for main contacts	0
<b>operating voltage</b>	
• at AC-3 rated value maximum	690 V
• at AC-3e rated value maximum	690 V
<b>operational current</b>	
• at AC-1 at 400 V at ambient temperature 40 °C rated value	22 A
• at AC-1	
— up to 690 V at ambient temperature 40 °C rated value	22 A
— up to 690 V at ambient temperature 60 °C rated value	20 A
• at AC-3	
— at 400 V rated value	12 A
— at 500 V rated value	9.2 A
— at 690 V rated value	6.7 A
• at AC-3e	
— at 400 V rated value	12 A
— at 500 V rated value	9.2 A
— at 690 V rated value	6.7 A
• at AC-4 at 400 V rated value	8.5 A
• at AC-5a up to 690 V rated value	19.4 A
• at AC-5b up to 400 V rated value	9.9 A
• at AC-6a	
— up to 230 V for current peak value n=20 rated value	7.2 A
— up to 400 V for current peak value n=20 rated value	7.2 A
— up to 500 V for current peak value n=20 rated value	7.2 A
— up to 690 V for current peak value n=20 rated value	6.7 A
• at AC-6a	
— up to 230 V for current peak value n=30 rated value	4.8 A
— up to 400 V for current peak value n=30 rated value	4.8 A
— up to 500 V for current peak value n=30 rated value	4.8 A
— up to 690 V for current peak value n=30 rated value	4.8 A
minimum cross-section in main circuit at maximum AC-1 rated value	4 mm <sup>2</sup>
<b>operational current for approx. 200000 operating cycles at AC-4</b>	
• at 400 V rated value	4.1 A
• at 690 V rated value	3.3 A
<b>operational current</b>	
• <b>at 1 current path at DC-1</b>	
— at 24 V rated value	20 A
— at 60 V rated value	20 A
— at 110 V rated value	2.1 A
— at 220 V rated value	0.8 A
— at 440 V rated value	0.6 A
— at 600 V rated value	0.6 A
• <b>with 2 current paths in series at DC-1</b>	
— at 24 V rated value	20 A
— at 60 V rated value	20 A
— at 110 V rated value	12 A
— at 220 V rated value	1.6 A
— at 440 V rated value	0.8 A
— at 600 V rated value	0.7 A
• <b>with 3 current paths in series at DC-1</b>	
— at 24 V rated value	20 A

<ul style="list-style-type: none"> <li>— at 60 V rated value</li> <li>— at 110 V rated value</li> <li>— at 220 V rated value</li> <li>— at 440 V rated value</li> <li>— at 600 V rated value</li> </ul>	20 A 20 A 20 A 1.3 A 1 A
<ul style="list-style-type: none"> <li>● <b>at 1 current path at DC-3 at DC-5</b> <ul style="list-style-type: none"> <li>— at 24 V rated value</li> <li>— at 60 V rated value</li> <li>— at 110 V rated value</li> </ul> </li> </ul>	20 A 0.5 A 0.15 A
<ul style="list-style-type: none"> <li>● <b>with 2 current paths in series at DC-3 at DC-5</b> <ul style="list-style-type: none"> <li>— at 24 V rated value</li> <li>— at 60 V rated value</li> <li>— at 110 V rated value</li> </ul> </li> </ul>	20 A 5 A 0.35 A
<ul style="list-style-type: none"> <li>● <b>with 3 current paths in series at DC-3 at DC-5</b> <ul style="list-style-type: none"> <li>— at 24 V rated value</li> <li>— at 60 V rated value</li> <li>— at 110 V rated value</li> <li>— at 220 V rated value</li> <li>— at 440 V rated value</li> <li>— at 600 V rated value</li> </ul> </li> </ul>	20 A 20 A 20 A 1.5 A 0.2 A 0.2 A
<b>operating power</b> <ul style="list-style-type: none"> <li>● at AC-3               <ul style="list-style-type: none"> <li>— at 230 V rated value</li> <li>— at 400 V rated value</li> <li>— at 500 V rated value</li> <li>— at 690 V rated value</li> </ul> </li> <li>● at AC-3e               <ul style="list-style-type: none"> <li>— at 230 V rated value</li> <li>— at 400 V rated value</li> <li>— at 500 V rated value</li> <li>— at 690 V rated value</li> </ul> </li> </ul>	3 kW 5.5 kW 5.5 kW 5.5 kW  3 kW 5.5 kW 5.5 kW 5.5 kW
<b>operating power for approx. 200000 operating cycles at AC-4</b> <ul style="list-style-type: none"> <li>● at 400 V rated value</li> <li>● at 690 V rated value</li> </ul>	2 kW 2.5 kW
<b>operating apparent power at AC-6a</b> <ul style="list-style-type: none"> <li>● up to 230 V for current peak value n=20 rated value</li> <li>● up to 400 V for current peak value n=20 rated value</li> <li>● up to 500 V for current peak value n=20 rated value</li> <li>● up to 690 V for current peak value n=20 rated value</li> </ul>	2.8 kVA 4.9 kVA 6.2 kVA 8 kVA
<b>operating apparent power at AC-6a</b> <ul style="list-style-type: none"> <li>● up to 230 V for current peak value n=30 rated value</li> <li>● up to 400 V for current peak value n=30 rated value</li> <li>● up to 500 V for current peak value n=30 rated value</li> <li>● up to 690 V for current peak value n=30 rated value</li> </ul>	1.9 kVA 3.3 kVA 4.1 kVA 5.7 kVA
<b>short-time withstand current in cold operating state up to 40 °C</b> <ul style="list-style-type: none"> <li>● limited to 1 s switching at zero current maximum</li> <li>● limited to 5 s switching at zero current maximum</li> <li>● limited to 10 s switching at zero current maximum</li> <li>● limited to 30 s switching at zero current maximum</li> <li>● limited to 60 s switching at zero current maximum</li> </ul>	200 A; Use minimum cross-section acc. to AC-1 rated value 123 A; Use minimum cross-section acc. to AC-1 rated value 96 A; Use minimum cross-section acc. to AC-1 rated value 74 A; Use minimum cross-section acc. to AC-1 rated value 61 A; Use minimum cross-section acc. to AC-1 rated value
<b>no-load switching frequency</b> <ul style="list-style-type: none"> <li>● at DC</li> </ul>	10 000 1/h
<b>operating frequency</b> <ul style="list-style-type: none"> <li>● at AC-1 maximum</li> <li>● at AC-2 maximum</li> <li>● at AC-3 maximum</li> <li>● at AC-3e</li> </ul>	1 000 1/h 750 1/h 750 1/h

— maximum	750 1/h
● at AC-4 maximum	250 1/h
<b>Control circuit/ Control</b>	
<b>type of voltage of the control supply voltage</b>	DC
<b>control supply voltage at DC rated value</b>	24 V
<b>operating range factor control supply voltage rated value of magnet coil at DC</b>	
● initial value	0.8
● full-scale value	1.1
<b>closing power of magnet coil at DC</b>	4 W
<b>holding power of magnet coil at DC</b>	4 W
<b>closing delay</b>	
● at DC	30 ... 100 ms
<b>opening delay</b>	
● at DC	7 ... 13 ms
<b>arcing time</b>	10 ... 15 ms
<b>control version of the switch operating mechanism</b>	Standard A1 - A2
<b>Auxiliary circuit</b>	
number of NC contacts for auxiliary contacts instantaneous contact	0
number of NO contacts for auxiliary contacts instantaneous contact	1
operational current at AC-12 maximum	10 A
<b>operational current at AC-15</b>	
● at 230 V rated value	10 A
● at 400 V rated value	3 A
● at 500 V rated value	2 A
● at 690 V rated value	1 A
<b>operational current at DC-12</b>	
● at 24 V rated value	10 A
● at 48 V rated value	6 A
● at 60 V rated value	6 A
● at 110 V rated value	3 A
● at 125 V rated value	2 A
● at 220 V rated value	1 A
● at 600 V rated value	0.15 A
<b>operational current at DC-13</b>	
● at 24 V rated value	10 A
● at 48 V rated value	2 A
● at 60 V rated value	2 A
● at 110 V rated value	1 A
● at 125 V rated value	0.9 A
● at 220 V rated value	0.3 A
● at 600 V rated value	0.1 A
<b>contact reliability of auxiliary contacts</b>	1 faulty switching per 100 million (17 V, 1 mA)
<b>UL/CSA ratings</b>	
<b>full-load current (FLA) for 3-phase AC motor</b>	
● at 480 V rated value	11 A
● at 600 V rated value	11 A
<b>yielded mechanical performance [hp]</b>	
● for single-phase AC motor	
— at 110/120 V rated value	0.5 hp
— at 230 V rated value	2 hp
● for 3-phase AC motor	
— at 200/208 V rated value	3 hp
— at 220/230 V rated value	3 hp
— at 460/480 V rated value	8 hp
— at 575/600 V rated value	10 hp
<b>contact rating of auxiliary contacts according to UL</b>	A600 / Q600

Short-circuit protection	
design of the miniature circuit breaker for short-circuit protection of the auxiliary circuit up to 230 V	C characteristic: 10 A; 0.4 kA
<b>design of the fuse link</b> <ul style="list-style-type: none"> <li>• for short-circuit protection of the main circuit <ul style="list-style-type: none"> <li>— with type of coordination 1 required</li> <li>— with type of coordination 2 required</li> </ul> </li> <li>• for short-circuit protection of the auxiliary switch required</li> </ul>	gG: 50 A (690 V, 100 kA), aM: 20 A (690 V, 100 kA), BS88: 35 A (415 V, 80 kA) gG: 20 A (690 V, 100 kA), aM: 16 A (690 V, 100 kA), BS88: 20 A (415 V, 80 kA) gG: 10 A (500 V, 1 kA)
Installation/ mounting/ dimensions	
<b>mounting position</b>	+/-180° rotation possible on vertical mounting surface; can be tilted forward and backward by +/- 22.5° on vertical mounting surface
fastening method side-by-side mounting	Yes
<b>fastening method</b>	screw and snap-on mounting onto 35 mm DIN rail according to DIN EN 60715
<b>height</b>	58 mm
<b>width</b>	45 mm
<b>depth</b>	73 mm
<b>required spacing</b> <ul style="list-style-type: none"> <li>• with side-by-side mounting <ul style="list-style-type: none"> <li>— forwards</li> <li>— upwards</li> <li>— downwards</li> <li>— at the side</li> </ul> </li> <li>• for grounded parts <ul style="list-style-type: none"> <li>— forwards</li> <li>— upwards</li> <li>— at the side</li> <li>— downwards</li> </ul> </li> <li>• for live parts <ul style="list-style-type: none"> <li>— forwards</li> <li>— upwards</li> <li>— downwards</li> <li>— at the side</li> </ul> </li> </ul>	10 mm 10 mm 10 mm 0 mm  10 mm 10 mm 6 mm 10 mm  10 mm 10 mm 10 mm 6 mm
Connections/ Terminals	
<b>type of electrical connection</b> <ul style="list-style-type: none"> <li>• for main current circuit</li> <li>• for auxiliary and control circuit</li> <li>• at contactor for auxiliary contacts</li> <li>• of magnet coil</li> </ul>	screw-type terminals screw-type terminals Screw-type terminals Screw-type terminals
<b>type of connectable conductor cross-sections</b> <ul style="list-style-type: none"> <li>• for main contacts <ul style="list-style-type: none"> <li>— solid</li> <li>— solid or stranded</li> <li>— finely stranded with core end processing</li> </ul> </li> <li>• for AWG cables for main contacts</li> </ul>	2x (0.5 ... 1.5 mm <sup>2</sup> ), 2x (0.75 ... 2.5 mm <sup>2</sup> ), 2x 4 mm <sup>2</sup> 2x (0.5 ... 1.5 mm <sup>2</sup> ), 2x (0.75 ... 2.5 mm <sup>2</sup> ), 2x 4 mm <sup>2</sup> 2x (0.5 ... 1.5 mm <sup>2</sup> ), 2x (0.75 ... 2.5 mm <sup>2</sup> ) 2x (20 ... 16), 2x (18 ... 14), 2x 12
<b>connectable conductor cross-section for main contacts</b> <ul style="list-style-type: none"> <li>• solid</li> <li>• stranded</li> <li>• finely stranded with core end processing</li> </ul>	0.5 ... 4 mm <sup>2</sup> 0.5 ... 4 mm <sup>2</sup> 0.5 ... 2.5 mm <sup>2</sup>
<b>connectable conductor cross-section for auxiliary contacts</b> <ul style="list-style-type: none"> <li>• solid or stranded</li> <li>• finely stranded with core end processing</li> </ul>	0.5 ... 4 mm <sup>2</sup> 0.5 ... 2.5 mm <sup>2</sup>
<b>type of connectable conductor cross-sections</b> <ul style="list-style-type: none"> <li>• for auxiliary contacts <ul style="list-style-type: none"> <li>— solid or stranded</li> <li>— finely stranded with core end processing</li> </ul> </li> <li>• for AWG cables for auxiliary contacts</li> </ul>	2x (0.5 ... 1.5 mm <sup>2</sup> ), 2x (0.75 ... 2.5 mm <sup>2</sup> ), 2x 4 mm <sup>2</sup> 2x (0.5 ... 1.5 mm <sup>2</sup> ), 2x (0.75 ... 2.5 mm <sup>2</sup> ) 2x (20 ... 16), 2x (18 ... 14), 2x 12
<b>AWG number as coded connectable conductor cross section for main contacts</b>	20 ... 12
<b>AWG number as coded connectable conductor cross section for auxiliary contacts</b>	20 ... 12

Safety related data		
<b>product function</b>		
<ul style="list-style-type: none"> <li>• mirror contact according to IEC 60947-4-1</li> <li>• positively driven operation according to IEC 60947-5-1</li> <li>• suitable for safety function</li> </ul>	Yes; with 3RH29 No Yes	
suitability for use safety-related switching OFF	Yes	
<b>service life maximum</b>	20 a	
<b>test wear-related service life necessary</b>	Yes	
<b>proportion of dangerous failures</b>		
<ul style="list-style-type: none"> <li>• with low demand rate according to SN 31920</li> <li>• with high demand rate according to SN 31920</li> </ul>	40 % 73 %	
<b>B10 value with high demand rate according to SN 31920</b>	1 000 000	
<b>failure rate [FIT] with low demand rate according to SN 31920</b>	100 FIT	
ISO 13849		
<b>device type according to ISO 13849-1</b>	3	
<b>overdimensioning according to ISO 13849-2 necessary</b>	Yes	
IEC 61508		
<b>safety device type according to IEC 61508-2</b>	Type A	
Electrical Safety		
<b>protection class IP on the front according to IEC 60529</b>	IP20	
<b>touch protection on the front according to IEC 60529</b>	finger-safe, for vertical contact from the front	
Approvals Certificates		
Environmental Product Declaration		
<ul style="list-style-type: none"> <li>• global warming potential [CO2 eq] / during manufacturing</li> <li>• global warming potential [CO2 eq] / during operation</li> <li>• global warming potential [CO2 eq] / after end of life</li> <li>• global warming potential [CO2 eq] / total</li> </ul>	1.42 kg 152 kg -0.305 kg 153 kg	
<b>Environment</b>	<b>General Product Approval</b>	
<a href="#">Environmental Confirmations</a>     		
<b>General Product Approval</b>	<b>EMV</b>	<b>Test Certificates</b>
    		<a href="#">Miscellaneous</a>
<b>Test Certificates</b>	<b>Maritime application</b>	
<a href="#">Special Test Certificate</a> <a href="#">Type Test Certificates/Test Report</a>	   	
<b>Maritime application</b>	<b>other</b>	
  	<a href="#">Miscellaneous</a>	<a href="#">Confirmation</a> <a href="#">Miscellaneous</a>
<b>other</b>	<b>Railway</b>	<b>Dangerous goods</b>



Further information

Information on the packaging

<https://support.industry.siemens.com/cs/ww/en/view/109813875>

Information for data generation and storage

<https://support.industry.siemens.com/cs/ww/en/view/109995012>

Information- and Downloadcenter (Catalogs, Brochures,...)

<https://www.siemens.com/ic10>

Industry Mall (Online ordering system)

<https://mall.industry.siemens.com/mall/en/en/Catalog/product?mlfb=3RT2017-1BB41>

Service&Support (Manuals, Certificates, Characteristics, FAQs,...)

<https://support.industry.siemens.com/cs/ww/en/ps/3RT2017-1BB41>

Image database (product images, 2D dimension drawings, 3D models, device circuit diagrams, EPLAN macros, ...)

[https://www.automation.siemens.com/bilddb/cax\\_de.aspx?mlfb=3RT2017-1BB41&lang=en](https://www.automation.siemens.com/bilddb/cax_de.aspx?mlfb=3RT2017-1BB41&lang=en)

Cax online generator

<https://support.automation.siemens.com/WW/CAXorder/default.aspx?lang=en&mlfb=3RT2017-1BB41>

Characteristic curves

[https://curves.simaris.siemens.com/curves/<mmp\\_prod\\_noCOMP="HAUPT"></mmp\\_prod\\_no>](https://curves.simaris.siemens.com/curves/<mmp_prod_noCOMP=)

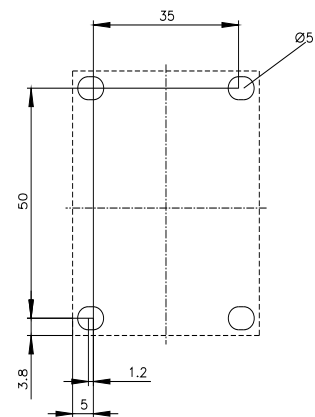
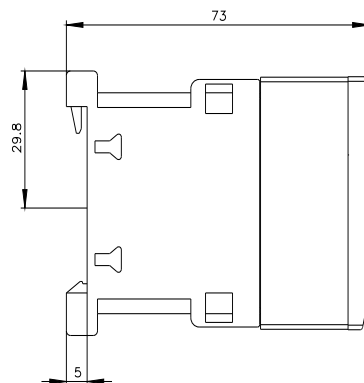
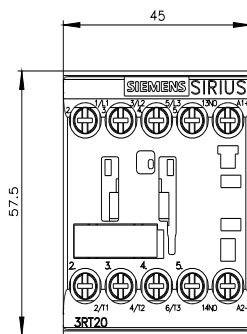

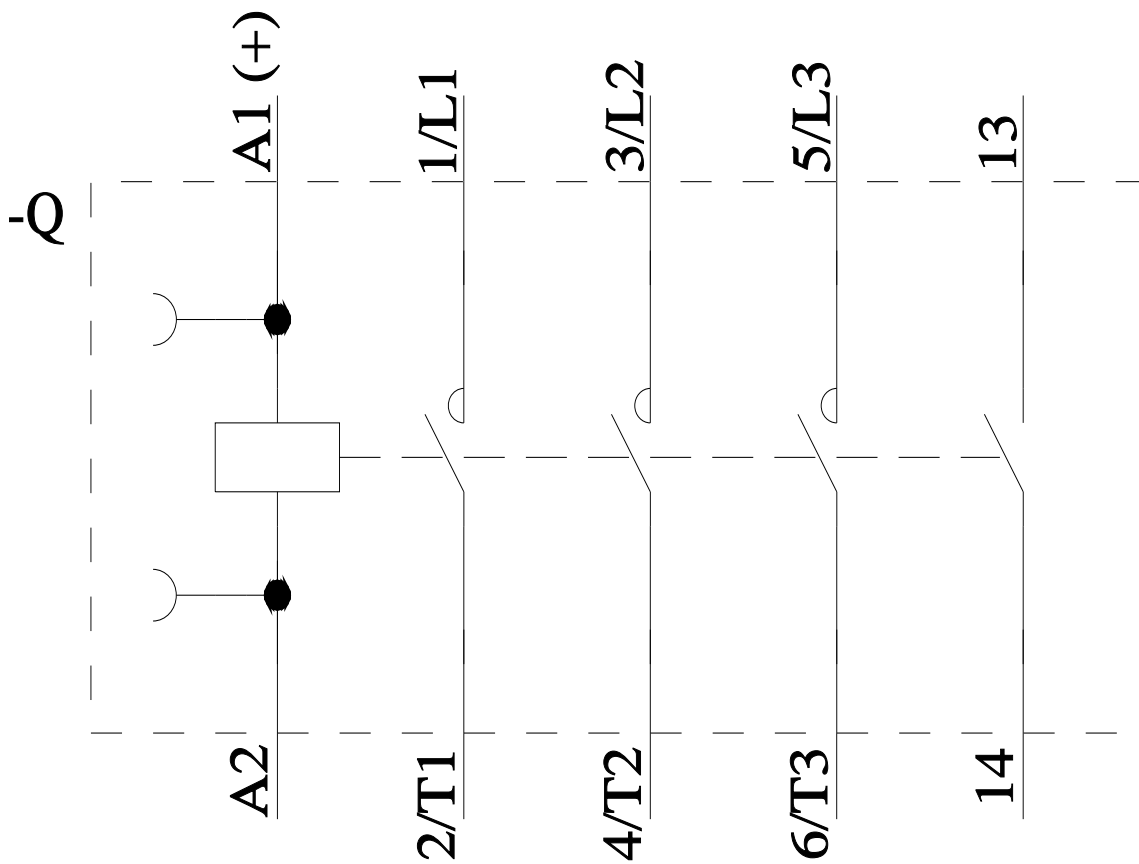

last modified:

4/4/2026 ↻